

Article number: 204160M16150D1U

Description: E+G levelling foot
GN 41-60-M16-150-D1-U

Note: U Without nut, Hexagon socket at the top, Wrench flat at the bottom

Measures

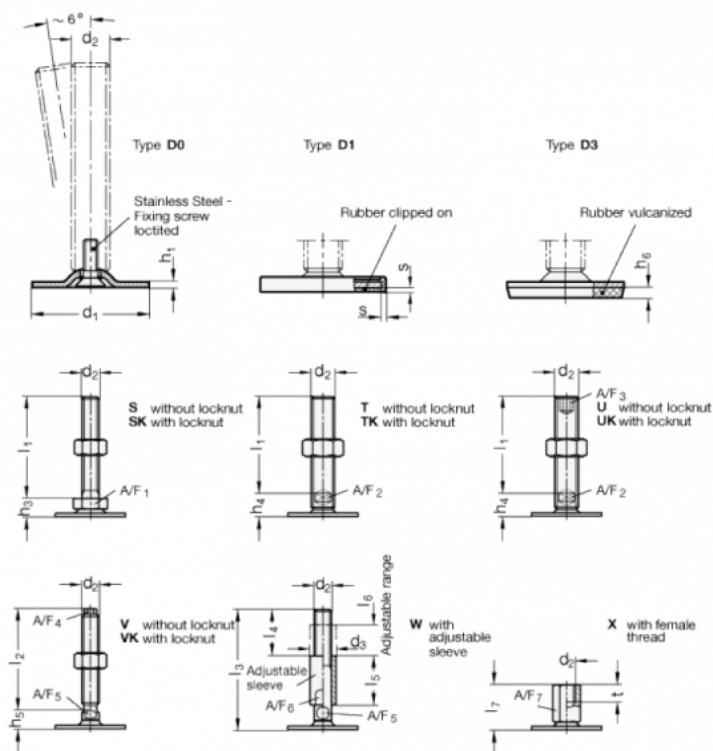

A/F2 = 12	s = 2
A/F3 = 8	
d1 = 60	
d2 = M16	
h1 = 2.5	
h4 = 17	
h6 =	
l1 = 150	